

1004D4 API Bottom Loading Coupler

H32096PA
 May 2011

The 1004D4 is the next generation API Bottom Loading Coupler from OPW Engineered Systems. By combining easy maintenance with an innovative spring loaded sleeve design we've made operating and servicing of your couplers a breeze.



1004D4

BENEFITS

- **Semi-Automatic Design** – Sleeve is spring energized to automatically “jump-on” adaptor.
- **Easy Maintenance** – Innovative shaft stuff box design provides the easiest maintenance of any coupler on the market. No special tools required.
- **No Drive Pins** – Drive Pins have been eliminated to improve serviceability.
- **5 Cam/Interlock Design** – 5 Cam design insures tight connection and security at all times.
- **Compatibility** – New Fluorocarbon blend is compatible with most fuel blends including gasoline, diesel, biodiesel, and ethanol.

Easy and inexpensive to maintain!

SELECTION GUIDE

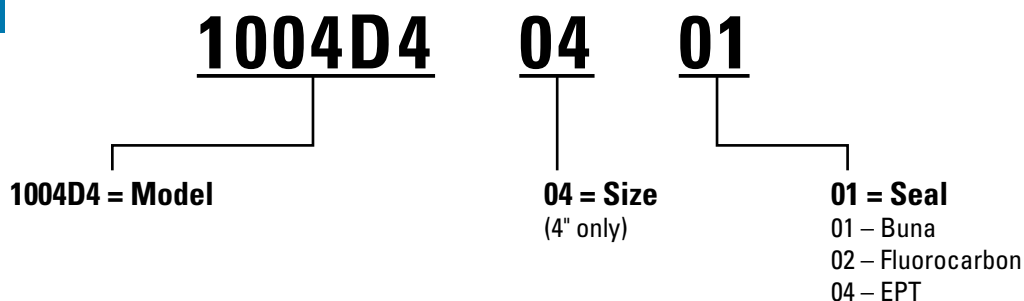

Design Parameters		Materials	
Max Design Pressure:	125 psi (g), 8.6 bar (g)	Body, Sleeve, Poppet	ASTM B26 Anodized (Aluminum A356-T6)
Max Allowable Working Pressure:	75 psi (g), 5 bar (g)	Cam	ASTM A351 CF8M (316 SST)
Max Flow Rate:	600GPM, 135 M3/H	Cylinder	ASTM SB241(Aluminum 6061-T6)
Max Temperature:	See seal options (page 3)	Shaft	ASTM A564 (13-8 Condition RH 950 SST)
Weight:	18.5 lbs (8.39 kg)	Seals	See Seal Options
Pressure Drop (At Max Flow Rate)	2-5 psi (g), .24 bar (g)	Clevis Pin	ASTM SA564 (17-4 PH SST, H900 Hardened)

*Unit tested to 300 psi (21 bar) in the closed position to withstand excessive thermal expansion. Reference API Standard RP-1004 for additional information.

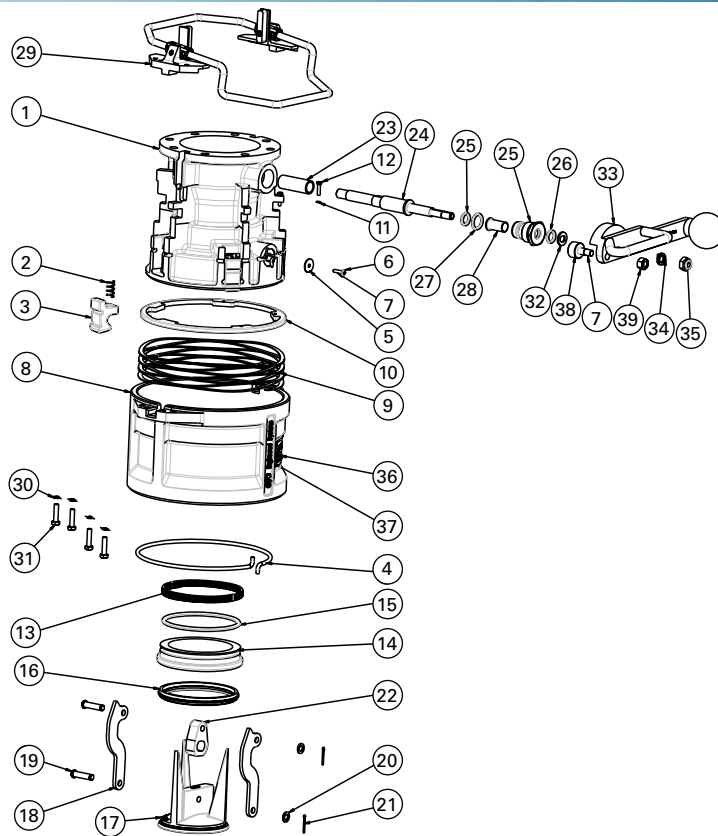

#	Description	Qty	Material	Part #	
1	Body	1	ASTM B26 Anodized (Aluminum A356-T6)	E20065AH	
2	Spring	5	Type 302 Stainless Steel	H32170M	
3	Cam	5	ASTM A351 CF8M (316 SST)	9C21327EW	
4	Cam Retaining Ring	1	ASTM A693 (17-7 PH SST, H900 Hardened)	H32225M	
5	Fender Washer	1	316 Stainless Steel	H32252M	
6	Sheet Metal Screw	1	Steel, Zinc Plated	H32251M	
7	Loctite	As Required	Thread Locking Compound	TYPE 242	
8	Sleeve	1	ASTM B26 Anodized (Aluminum A356-T6)	E20063AH	
9	Jump on Wave Spring	1	ASTM A693 (17-7 PH SST, H900 Hardened)	H32055M	
10	Wave Spring Support Ring	1	304 SST	D20205RE	
11	M4 Spring Lock Washer	3	316 SST	H32082M	
12	M4 X .7mm by 16mm Hex Cap Screw	3	316 SST	H32081M	
13	Wave Spring	1	ASTM A693 (17-7 PH SST, H900 Hardened)	H31091M	
14	Cylinder	1	ASTM SB241 (Aluminum 6061-T6)	C21283AH	
15	Cylinder O-Ring	1	See Seal Options Chart	-	*
16	Nose Seal, API CPLR, Fluorocarbon	1	See seal Options Chart	-	*
17	Poppet	1	ASTM B26 Anodized (Aluminum A356-T6)	D20069AH	
18	High Pressure Link	2	410 SST Hardened	H30552M	
19	Clevis Pin	2	ASTM SA564 (17-4 PH SST, H900 Hardened)	H30610RE	
20	Washer, Flat, SST, 5/16	2	18-8 SST	H30206M	
21	Cotter Pin	2	SST	H30205M	
22	Drive Link	1	ASTM A351 CF-8M (316 SST)	C21255EW	
23	Tube Spacer, API, SST	1	316 SST	C21254RE	
24	Handle Shaft	1	ASTM A564 (13-8, Condition RH 950, RC 48)	C21290RE	
25	Stuff Box, API and LOK, SST	1	ASTM A479 316 (316L)	C20812RE	
26	O-Ring, Fluorocarbon	2	See Seal Options Chart	-	*
27	O-Ring, Fluorocarbon	1	See Seal Options Chart	-	*
28	Sleeve Bearing	1	Teflon/Graphite	H32163M	*
29	Recock Handle Assembly	1	SST	D20217	
30	M6 Spring Lock Washer	8	316 SST	H32084M	
31	M6 X 1.0mm by 25mm Hex Cap Screw	8	316 SST	H32083M	
32	Load Distribution Washer	1	.75 inch Stock AISI 410 SST Bar Stock	H32246RE	
33	Operating Handle	1	ASTM A351CF8M (316 SST)	E20070EW	
34	Washer, Nord-lock,	1	SST ANSI 316	H31920M	*
35	Distorted Thread Nut, 10mm	1	Steel, Zinc Plated. M10 x 1.5mm	H32256M	
36	Nameplate	1	0.12 Satin		
37	6-20 X 3/16" Long Thread Screw	4	Type B, Steel, Zinc Plated	H32149M	
38	Roller Bearing	1	Steel Construction, Sealed Bearings	H30219M	
39	Nut, Hex, CST, ZP, 3/8"-24	1	ZP CST	H30220M	

* Items included in seal replacement kits (1004D4SRK)

IMPORTANT: OPW products should be used in compliance with applicable federal, state, provincial, and local laws and regulations. Product selection should be based on physical specifications and limitations and compatibility with the environment and materials to be handled. OPW MAKES NO WARRANTY OF FITNESS FOR A PARTICULAR USE. All illustrations and specifications in this literature are based on the latest product information available at the time of publication. OPW reserves the right to make changes at any time in prices, materials, specifications, and models and to discontinue models without notice or obligation.

SEAL OPTIONS

Seal Material	Coupler Model #	Nose Seal (16)	Stuff Box Seal (26)	Stuff Box Seal (27)	Cylinder Seal (15)	Temp Rating
Buna N 1500	1004D4-0401	H30482M	H20129M	H31705M	H30258M	-20°F - 212°F (-29°C - 100° C)
Fluorocarbon	1004D4-0402	H30483M	H20175M	H31706M	H30217M	-20°F - 400°F (-29°C - 204° C)
EPT E 692	1004D4-0404	H31957M	H20176M	H31707M	H31956M	-50°F - 225°F (-46°C - 107° C)

Consult factory for additional seal options.

SEAL REPLACEMENT KITS

OPW 1004D4SRK Seal Replacement Kits include everything needed to change the seals in the 1004D4 API coupler.

Seal Replacement Kits are always recommended as spare parts.

Seal Material	Seal Replacement Kit Part #
Buna N 1500	1004D4SRK-0401
Fluorocarbon	1004D4SRK-0402
EPT E 692	1004D4SRK-0404

Tools Needed

- 11/16 inch or 17 mm socket
- 1-1/4 inch or 32 mm deep reach socket

ASSEMBLY

API Coupler Installation Preparations

Safety Precautions

Warning: Read and understand these instructions before starting installation:

- Coupler to be used for its designated purpose only.
- Local regulations for (un)loading must be followed at all times.
- Product flow may result in static electricity; grounding of equipment is required.
- **Although the 1004D4 is designed for higher pressures, proper measures must be taken within the system to allow for thermal expansion.**
- OPW instructions must be followed for installation.

Make sure to use adequate personal protection at all times during operation.

Note: All images depict the 1004D4.

Step 1

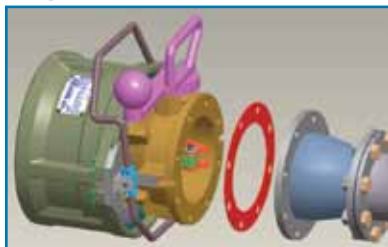

- Secure whatever device coupler will be mounted to the e.g. loading arm.
- Sandwich gasket between coupler and load device flanges.

Step 2



- Align coupler bolt holes with bolt holes on loading device.
- Insert two bolts into the highest bolt holes on the flange and hand tighten. This is to secure coupler and prevent damage due to bending moment as the remaining bolts are installed.

Warning: Under pressure, poppet will cause handle to rotate violently if not restrained

Step 3

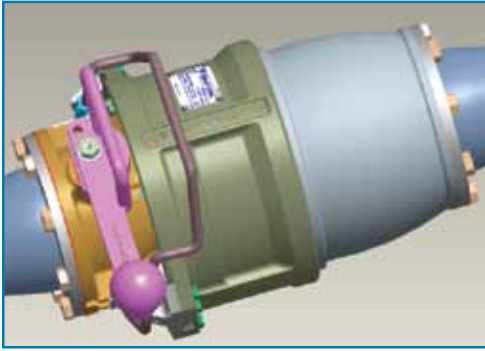

- Connect the coupler to the adapter. The sleeve will slide completely, fully forward. Fully rotate the operating handle and in the open position, the operating handle cam surface should prevent the sleeve from sliding back.

MAINTENANCE

Consider the following when servicing the coupler:

- When coupler is over pressurized, it must be inspected thoroughly.
- After maintenance is performed, it must be tested before the next use (see Coupler Testing).
- Periodical inspection (every 3 months) for leakages (especially with toxic or hazardous mediums).
- Maintenance must be performed by authorized personnel.
- Periodical maintenance (once a year) is required according to the maintenance instructions.
- When any leakages are found, have seals replaced immediately to obtain a safe and correct use of the coupler. If leakages continue contact the OPW distributor or the OPW Engineered Systems for consultation.

DISASSEMBLY INSTRUCTIONS

Step 1: Dismantle API Coupler

Attention: Dismantling must be performed by authorized and trained personnel only.

Attention: The same risks and procedures of initial installation apply.

Before dismantling coupler make some necessary preparations

Figure A



- Secure from movement the device the coupler is attached to (Figure A)

Figure B



- Make sure to use adequate personal protection at all times during the operation.
- Clear surrounding areas and shut off any working devices.
- Make sure the surrounding area is clear from obstacles.
- Barricade surrounding area, so no unauthorized persons can access work floor.
- Arrange necessary permits or paperwork with plant holder, owners or local authorities, before taking any actions.

When the coupler is clean and dry and the necessary preparations have been made, the coupler can be disassembled from the device it is attached to.

- With the corresponding loading arm secured from movement, loosen bolts mounting the coupler to the loading arm. Support coupler while removing all bolts except top two. This is to prevent bending moments from causing damage to the flanges and bolts (Figure B).
- While supporting the loose coupler, remove the final two bolts. Coupler should fall away.
- Remove gasket between both flanges.

Step 2:

- Place the coupler such that the flange side is resting on a work surface. Using the 6.0 inch diameter ring supplied with the seal kit, center the ring on all of the cams. Using your fingers, carefully press on the ring and compress the cams. The coupler will close and the sleeve will slide completely forward. Rotate the coupler 180° and rotate the operating handle.

Step 3:



- Remove the 10mm nut and Nord-lock washer using the 11/16 inch or 17mm deep reach socket. Discard the nut and Nord-lock washer. Remove operating handle.

Step 4:



- Remove the load distribution washer, stuff box, seals, and sleeve bearing. Remove the stuff box using the 1-1/4 inch or 32mm deep reach socket. Discard the load distribution washer.

Step 5:

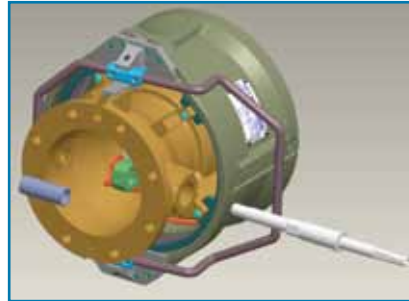

- Remove the handle shaft through the body being careful to catch the tube spacer. Thoroughly clean the handle shaft and tube spacer and inspect for wear or damage.

Step 6:

- Remove the poppet assembly, cylinder, and cylinder wave spring.



Step 7:

- Remove the nose seal and O-ring from the cylinder. Thoroughly clean the cylinder and inspect for wear or damage.

Step 8:

- Remove the 3 O-rings from the stuff box. Use the seal pick provided in the seal kit to remove the internal O-ring.
Note: The inner most stuff box O-ring may remain on the handle shaft after the stuff box is removed. Remove the sleeve bearing from the stuff box, discard.

ASSEMBLY INSTRUCTIONS

Step 1:

- Replace the nose seal and the cylinder O-ring. Lubricate the O-ring with light oil.

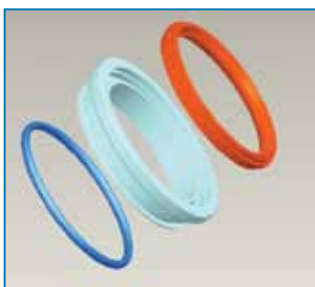

Step 2:

- Replace the interior, exterior O-rings, and the sleeve bearing in the stuff box. Lubricate the O-rings with light oil.

Step 3:

- Reinstall the cylinder wave spring and cylinder then the poppet assembly into the body.
- Important:** Note orientation of high pressure links to the through hole in the body.



Step 4:

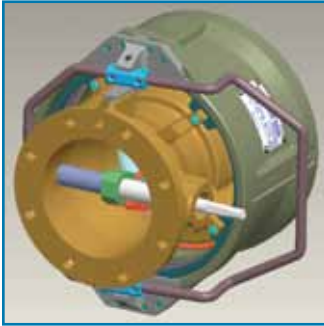

- Slide the handle shaft into the body and through the drive link. As the shaft just pokes through the drive link, install the tube spacer. Rotate the shaft until the flats on the shaft and the drive link align and then push the shaft through and into the body.

Step 5:

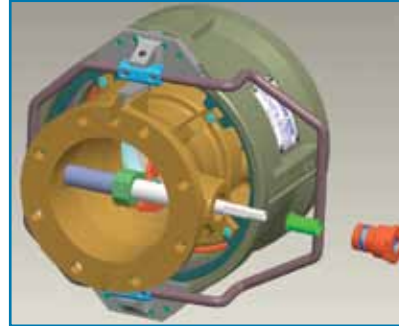

- Install the stuff box using the 1-1/4 inch or 32mm deep reach socket. Tighten the stuff box firmly into the body.

Step 6:

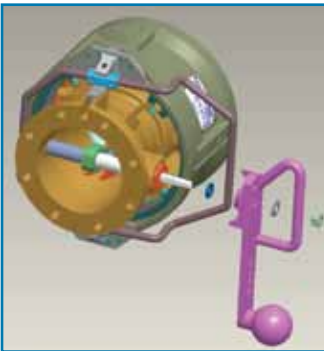

- Install the new load distribution washer on the handle shaft with the permanent mark toward the assembler. Install the operating handle, the new Nord-lock washer, and new 10mm nut. Tighten the 10mm nut using the 11/16 inch or 17mm deep reach socket to 25 ft.-lbs., or 34N-m torque.

Step 7:



- Fully rotate the operating handle to close the coupler. Grasp the bail on the operating handle and the recock handle assembly and move the recock handle towards you until the sleeve is fully retracted and locked.

Assembly Complete

Warning: With sleeve forward, operating handle is unlocked and can rotate. Do not apply pressure to handle unless trying to open valve. Use caution when working around handle when system is under pressure. Once handle starts moving pressure can cause it to rotate violently.

<p>WARNING</p> <p>Failure to follow these warnings could result in serious personal injury, property damage or product failure.</p>	<p>1) Do not attempt any maintenance service while the equipment is in operation. System pressure must be relieved and the product drained before attempting any service on the unit. The line must be locked out while service is in progress. Proper thermal relief must be provided at all times while equipment is in service.</p>	<p>2) OPW products do not eliminate possible exposure to hazardous substances. The conditions of handling and use are beyond our control, and we make no guarantee and assume no liability for damages or injuries related to the use of our products. Follow the safety precautions outlined in the Material Safety Data Sheets for the material being used. It is the responsibility of the user to comply with all federal, state and local regulations. Always employ proper safety precautions and handling techniques.</p>	<p>3) Proper seal and wetted material part selection is critical for safe operation. To assure maximum life for the service intended, use only those materials compatible with the fluids being handled. Please note material being supplied and make certain that it is suited for the intended service.</p>
--	--	--	---